

ROAD BIKE RIM



23mm Width 60mm Depth TUBELESS COMPATIBLE

SPECIFICATION

| | |
|--------------------|------------------------------------|
| Item # | NXT60C05 |
| Type | Clincher |
| Material | Toray T700 Carbon Fiber |
| Size | 700C |
| Width | 23mm |
| Depth | 60mm |
| ERD | 521mm |
| Weight | 510g |
| Weave | UD, 3K, 12K |
| Spoke Hole Dia. | 4.5mm |
| Valve Hole Dia. | 6.5mm |
| Assembly Hole Dia. | 7.5mm |
| Hole count | 16,18,20,24,28,32,36 |
| Application | Road / Triathlon / TT / Cyclocross |



PROFILE

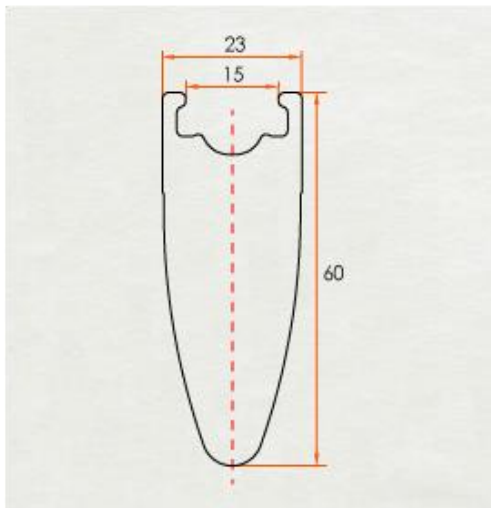

RECOMMENDATION

| | |
|---------------------|-----------|
| Max Tire Pressure | 140psi |
| Max Spoke Tension | 130kgf |
| Max Weight Limit | 130kg |
| Spoke Nipple Length | 14mm/16mm |

FEATRURES

Basalt Braking Surface: This rim has a high-temperature resistant basalt braking surface that dissipates heat build-up and provides consistently solid braking, even in hot temperatures on long descents. No Aluminum braking surface needed! Less rotational weight = faster acceleration!