

ROAD BIKE RIM



23mm Width 50mm Depth TUBELESS COMPATIBLE

SPECIFICATION

Item #	NXT50C06
Type	Clincher
Material	Toray T700 Carbon Fiber
Size	700C
Width	25mm
Depth	50mm
ERD	541mm
Weight	500g
Weave	UD, 3K, 12K
Spoke Hole Dia.	4.5mm
Valve Hole Dia.	6.5mm
Assembly Hole Dia.	7.5mm
Hole count	16,18,20,24,28,32,36
Application	Road / Triathlon / TT / Cyclocross



PROFILE

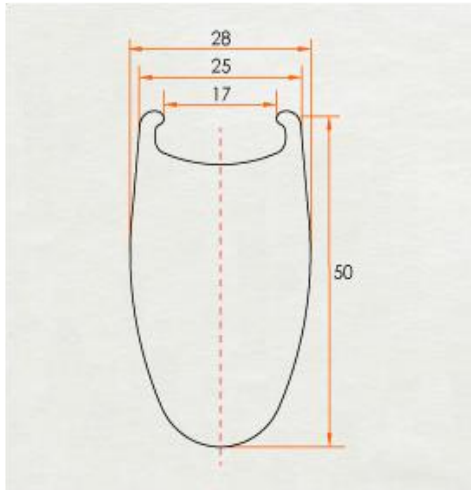

RECOMMENDATION

Max Tire Pressure	140psi
Max Spoke Tension	130kgf
Max Weight Limit	130kg
Spoke Nipple Length	14mm/16mm

FEATRURES

Basalt Braking Surface: This rim has a high-temperature resistant basalt braking surface that dissipates heat build-up and provides consistently solid braking, even in hot temperatures on long descents. No Aluminum braking surface needed! Less rotational weight = faster acceleration!